



Remote Controlled Dog Training Collars

**dogtra *EDGE***



***EDGE***

By Dogtra  
Remote Controlled Dog Training Collars

## **Owner's Manual**

Please read this manual thoroughly before operating the  
Dogtra EDGE training collar.

# **Product Safety and Health Statement**

## **Intended Use**

Dogtra e-collars are intended for behavior modification on dogs only. They are NOT intended for use on people or on animals other than dogs. Dogtra does not assume any liability for the improper use of any Dogtra e-collars.

## **Aggressive Behavior**

Dogtra highly recommends consulting a dog training professional when using an e-collar to correct dogs that are aggressive towards people or other dogs.

## **Electronic Interference**

Dogtra's industry-leading technology filtering system ensures minimal interference with other electronic devices (garage door openers, mobile phones, etc.). Our digital microprocessor offers thousands of unique codes to eliminate frequency match-ups with other Dogtra e-collars. Dogtra recommends consulting your physician if you are going to use the e-collar near any types of medical devices.

## **Safety Cut-off**

The constant stimulation will only activate for a maximum of 12 seconds. After 12 seconds of continuous stimulation, the stimulation will reset. The stimulation reactivates once the constant button is released and pressed again.

## **Proper Fit**

A proper fit is necessary for the Dogtra e-collar to work optimally. Both contact points must be in contact with your dogs skin at all times for a consistent stimulation. A loose fitting collar can cause the contact points to rub against the skin and cause irritation.

## **Duration your dog can wear the unit**

Leaving the e-collar in the same position on a dog's neck for extended periods of time can also cause skin irritation. To prevent this, occasionally reposition the e-collar so the contact points are moved to a different location on the dog's neck. ALWAYS check your dog's neck for signs of skin irritation when using an e-collar. If any signs of skin irritation are found, suspend e-collar training and consult with a veterinarian.

## **Stimulation Reaction**

Every dog has a different tolerance level and reaction to e-collar stimulation. Closely monitor your dog's reaction to find the right stimulation level. The stimulation level may vary depending on the training situation. When highly distracted, dogs will require a higher level of stimulation.



# Table of Contents

At a Glance .....	6
Main Features of the EDGE .....	7
Overview .....	8
Understanding your training system	
1. How to turn the EDGE on/off .....	10
2. How the transmitter mode buttons work .....	11
3. Collar fitting .....	13
4. How to find the right stimulation .....	14
5. To maximize the distance .....	14
6. The LED indicator .....	15
7. Charging the battery .....	15
8. How to change the stimulation intensity .....	17
9. What the LCD icons mean .....	19
10. Changing the receiver/collar location light color .....	19
11. Code Setting .....	20
12. How to change the length of the contact points .....	21
13. How to attach the belt clip on the EDGE .....	22
14. How to use the test light .....	23
15. How to change the battery .....	24
General Training Tips .....	28
Maintenance .....	30
Troubleshooting Guide .....	31
Warranty and repair information .....	33

## At a Glance

### - Included in the package -



Transmitter



Receiver/Collar



Battery charger



Splitter cable



Test light



Owner's manual



Exchangeable selector dial

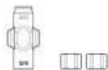

Contact point extension washer / adjustment tool



belt clip

### - Optional accessories -

#### Additional Receiver/Collars with straps

The Dogtra EDGE is expandable to a two, three, or four-dog system.

#### Field auto charger

Dogtra's field auto chargers are designed for use with a 10-volt car outlet.

#### European charger

Dogtra's european chargers are designed for use with a 230V AC electrical outlet.

To purchase accessories, please visit dogtra's online store at [shop.dogtra.com](http://shop.dogtra.com) or call customer service at 1-888-811-9111.

## Main Features of the EDGE



Interchangeable intensity dial



Rheostat/volume style with stimulation levels 0~127



Selector/step style with stimulation levels 0~8



1-mile range



Nick/Constant/non-stimulating Pager vibration modes



Location light with 4 selectable colors  
(white, red, blue and green)



User expandable to a two, three, or four-dog system



Replaceable batteries



Fully waterproof



LCD screen



Extendable contact points (5/8" to 3/4")



Belt clip



2-hour rapid charge batteries



# Overview

## EDGE Transmitter

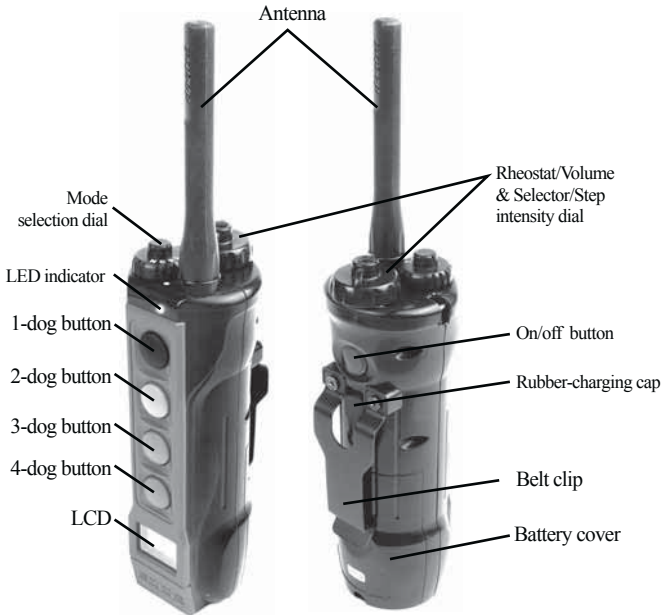

## EDGE Receiver/Collar

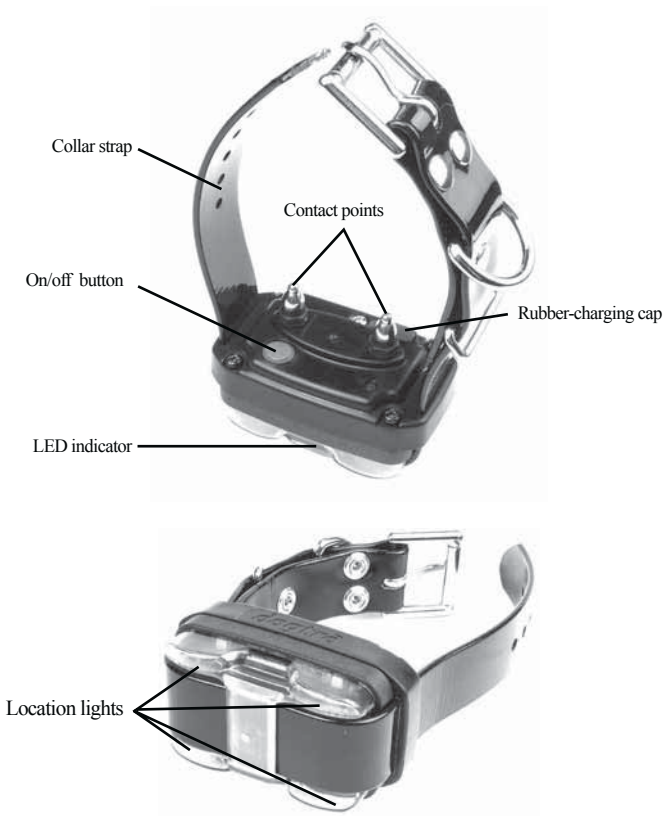

# Understanding your training system

## 1. How to turn the EDGE on/off

To turn the transmitter on, hold down the blue button on the back of the transmitter until the LCD screen illuminates. To turn the transmitter off, hold down the blue button on the back of the transmitter until the LCD screen shuts off.



To turn the receiver/collar on, hold down the on/off button until the LED indicator turns green. To turn the receiver/collar off, hold down the on/off button until the LED indicator turns red.

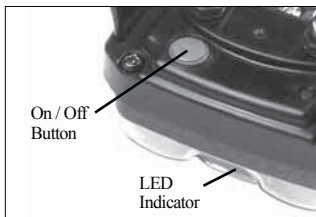

## 2. How the transmitter mode buttons work

Turn the mode selection dial to choose the function, and then press the button on the front that is set to the desired collar. The single dog EDGE transmitter comes set to the black button.

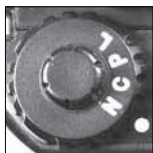

+



### **N (Nick)**

Nick is a single  $\frac{1}{2}$  second stimulation.



+



### **C (Constant)**

Constant gives a continuous stimulation while the button is pressed for up to 12 seconds.



+



### **P (Pager)**

Pager gives a non-stimulating vibration while the button is pressed for up to 12 seconds.



+



## **L (Light)**

High intensity LED location lights on the EDGE receiver/collar helps to find and distinguish dogs easily in low light/dark conditions.

To activate the light-locate mode, hold down the front transmitter button. The location light will continuously flash while the button is pressed, up to 12 seconds.

To activate the light-tracking mode, tap the front button on the transmitter once.

The receiver/collar LED location lights will now blink every 3 seconds.

To deactivate the light-tracking mode, tap the front button on the transmitter once more.



The buttons on the front of the transmitter enables control of up to 4 receiver/collars. Each of the 4 buttons on the transmitter can be coded to operate a different receiver/collar.

The receiver/collars can be distinguished by coding the transmitter button to the matching receiver/collar strap color.

Additional receiver/collars with straps are available online at [shop.dogtra.com](http://shop.dogtra.com) or by calling customer service at 1-888-811-9111.

### 3. Collar fitting

The collar should be fit so that the surgical stainless steel contact points are pressed firmly against the dog's skin. With a proper fit, you should be able to insert a finger or two snugly in between the contact points and your dog's skin. The best location for the receiver box is on either side of the dog's windpipe. The receiver box should stay in this position during any training or exercise. If the unit slips downward towards the dog's windpipe, the unit was NOT fastened firmly enough.

A loose fitting collar can cause the contact points to rub against the skin and cause irritation. If the collar is on too tight, the dog may have difficulty breathing. **ALWAYS** check your dog's neck for signs of skin irritation when using an e-collar. If any signs of skin irritation are found, suspend e-collar training and consult with a veterinarian.



#### 4. How to find the right stimulation

The EDGE unit comes installed with the rheostat dial on the transmitter. The rheostat intensity dial controls the stimulation level, with level 1 being the lowest level and level 127 being the highest. Switch to the included selector style intensity dial with 8 levels of stimulation, with 1 being the lowest level and level 8 being the highest. The level of stimulation best suited for your dog depends on your dog's temperament and threshold for stimulation. Always start at the lowest level and work your way up. The appropriate level can be found when the dog responds to the stimulation with a mild reaction, such as a tensing of the neck muscles. The stimulation level may vary depending on the training situation. When highly distracted, dogs will require a higher level of stimulation.

#### 5. To maximize the distance

The Dogtra EDGE has a 1-mile range. The range may vary depending on the way the transmitter is held. Hold the transmitter away from your body to receive the greatest range. For maximum signal strength, keep the Dogtra EDGE properly charged.



Maximum range



Typical range



Minimum range

\*Avoid touching the antenna or the range may decrease substantially.

## 6. The LED indicator

The LED indicator flashes every 4 seconds when the receiver is on and ready for use. The LED indicator will blink on both the transmitter and the receiver when the transmitter buttons are pressed.

The LED indicator color indicates the battery life level.

**Green** = Fully charged, **Amber** = Medium, **Red** = Needs charging

If the unit is used while the LED indicator is red, it will shut down automatically.



## 7. Charging the battery

1. Lift the rubber-charging cap and plug in the charger.
2. Plug the adapter's power plug in to a standard AC wall outlet.  
The LED indicator on the transmitter and receiver/collar will turn red.
3. When the unit is fully charged, the LED indicator will turn green on both the transmitter and receiver/collar. Unplug the adapter's power plug from the AC wall outlet and disconnect the charger from the unit.
4. Place the rubber-charging cap back over the charging port.



- \* The transmitter and receiver/collar rubber-charging cap ensures dirt and debris does not build up in the charging port area. The unit is waterproof even if the rubber-charging cap is not fully closed.

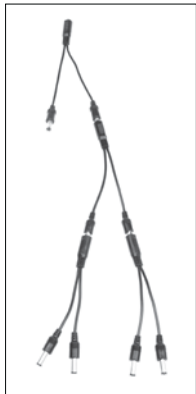

To charge multiple receiver/collars and a transmitter, combine additional battery charger splitter cables as shown.

**\* Warning**

1. Fully charge the unit before the first use.
2. Do not charge the unit near any flammable substances.
3. Fully charge the unit before storing for one month or longer.
4. Always use Dogtra approved charging adapters. When the wrong charging adapter is used, the LED indicator will not turn on or blink amber.

## 8. How to change the stimulation intensity

The Dogtra EDGE has the ability to switch between the rheostat/volume intensity and the selector/step intensity.

The EDGE unit comes installed with the rheostat dial knob in place. To switch to the selector/step dial, follow the steps below.

1. Turn the stimulation level to 0.
2. Unscrew the top of the dial with a flathead screwdriver counter-clockwise.
3. Remove the current dial knob and replace with the desired intensity dial type.
4. While firmly holding the dial knob in place, tighten the screw clockwise.

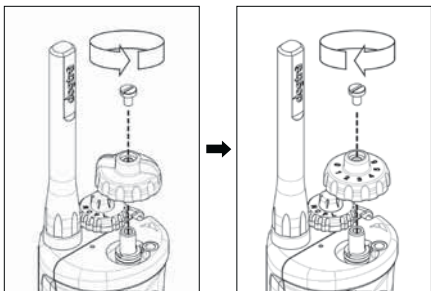

Next, change the program setting to the corresponding intensity dial type.

To change the program setting, follow the steps below.



1. Set the transmitter's intensity dial to 0.



2. Set the mode dial to "P".

Push  
simultaneously



3. Simultaneously hold down the black button on the front of the transmitter, along with the on/off blue button on the back of the transmitter.

4. The display on the LCD screen will now show the icon for the rheostat/volume or the selector/step. Repeat the steps from the beginning, to switch back and forth from the rheostat/volume and the selector/step style of intensity control.









Icon for the rheostat/volume



Icon for the selector/step

## 9. What the LCD icons mean

The icons on the LCD screen on the transmitter are listed below.

	Nick
	Constant
	Pager
	Light
	Rheostat/volume intensity control
	Selector/step intensity control
	Battery life indicator

## 10. Changing the receiver/collar location light color

The EDGE receiver/collar location light can be set to any of the 4 colors offered.

To change the receiver/collar location light to white, red, green, or blue, follow the instructions below,

1. Start with the receiver/collar turned off.
2. Hold down the on/off button on the receiver/collar for 10 seconds.
  - \* **Attention:** The on/off button must be pressed for a full 10 seconds.
3. Release the on/off button after the white location light flashes rapidly. The white location light will start flashing after the single green (small) LED indicator code setting light finishes blinking.
4. Press the on/off button once to set the desired color.
  - \* The location light colors will rotate in the order of white, red, green, and blue for two full rotations.
  - \* The location light color will reset to the corresponding color when re-coded to another button.

## 11. Code Setting

To set the coding for the Dogtra EDGE transmitter to an existing receiver/collar, or an Additional receiver/collar, follow the steps below.



1. Start by turning on the transmitter by holding down the on/off button on the back of the transmitter.



2. Set the transmitter's intensity dial to "0", and the mode selection dial to "C".



3. In the off position hold down the receiver/collar on/off button until the green LED indicator light begins to blink rapidly.



4. Immediately press the button on the transmitter of the color you would like the receiver/collar to be coded to.

**\*Attention:** Turn the mode selection dial to "P", or "L", to check that unit has been coded properly.

## 12. How to change the length of the contact points

The Dogtra EDGE comes equipped with standard 5/8" contact points that can be extended to 3/4" contact points, for use with dogs with longer coats.

To increase the contact point length from 5/8" to 3/4", follow the steps below.

1. Using the included adjustment tool with the side marked 5/8", unscrew the contact points counter-clockwise.
2. Place the contact point extension over the exposed threads, flat side down.
3. Place the contact points over the extensions and tighten the contact points and extensions clockwise using the adjustment tool with the side marked 3/4".

\* **Caution:** Tighten until firmly in place. Be careful not to over tighten.

To shorten the contact points back to the standard 5/8", start with the adjustment tool with the side marked 3/4", remove the contact point extensions, and tighten the contact points with the adjustment tool with the side marked 5/8".

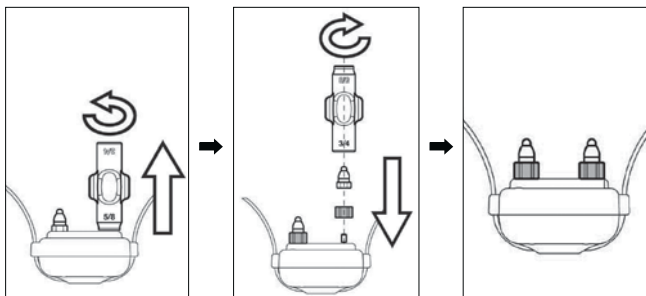

### 13. How to attach the belt clip on the EDGE

To attach the included belt clip to the transmitter, follow the instructions below.

1. Align the belt clip to the grooves on the back of the transmitter.
2. With a firm grip, screw on the belt clip using the provided Philips head screws.

**\* Caution \***

Tighten until firmly in place. Be careful not to over tighten.

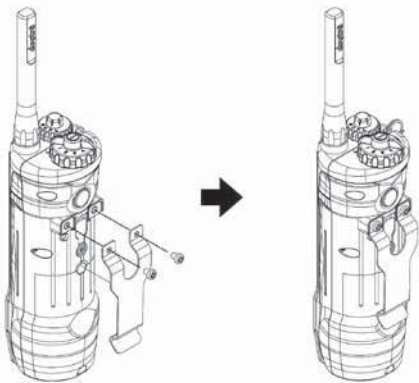

## 14. How to use the test light

Test for a stimulation using the included test light.

1. Turn on the receiver/collar and the transmitter and place the test light over the contact points as shown in the diagram.
  2. The test light will illuminate momentarily when the front transmitter button is pressed on the “N” mode. The light will stay lit as long as the front transmitter button is pressed on the “C” mode, up to 12 seconds.
- \* For more information on the “N” and “C” modes, see section 2. How the buttons work.
3. When the stimulation dial is turned up, the test light will emit a brighter light.

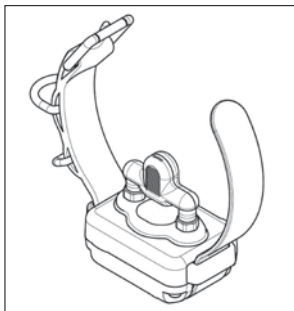

**NOTE:** The test light may not emit a visible light when the intensity level is set below 10. The test light may be difficult to see in bright light settings.



## 15. How to change the battery

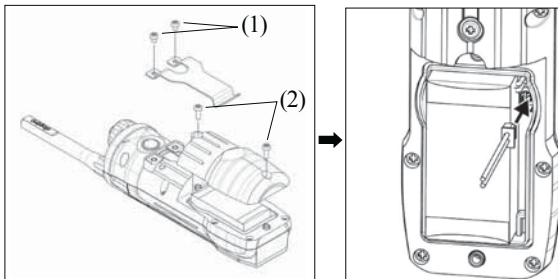

The Dogtra EDGE batteries are user replaceable.

To replace the battery in the transmitter, follow the instructions below.

1. Begin with the transmitter turned off.
2. Unscrew the two Phillips head screws attached to the back of the belt clip and remove the belt clip. – (1)
  - \* Unscrew the screws with a firm grip, taking extra caution to not strip the screws.
3. Unscrew the two screws on the back of the transmitter. – (2)
  - \* Unscrew the screws with a firm grip, taking extra caution to not strip the screws.
4. Holding the battery wire, detach the wire from the battery connector plug (see picture).
5. Holding the battery wire of the new battery, plug the wire in to the battery connector plug.
  - \* **Attention** : The battery wire plug in is indented to fit in one way to the connector.
6. Check that the battery connector wire is firmly inserted into the plug. The battery wires must be inside the battery compartment tucked neatly along the right side of the battery.



\* **Caution** - Do not detach the wire by pulling from the battery.



\* **Caution** - The battery wires must be inside the battery compartment tucked neatly along the right side of the battery.

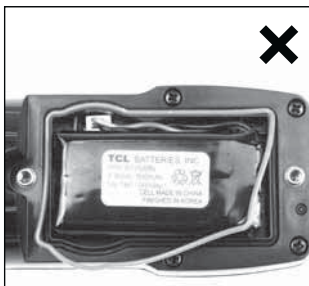

\* **Caution** - The orange rubber gasket is important for the unit to be waterproof and must be properly seated in place.

7. Fasten the battery cover and the belt clip back on the transmitter with the four screws.

## To replace the battery in the receiver/collar,

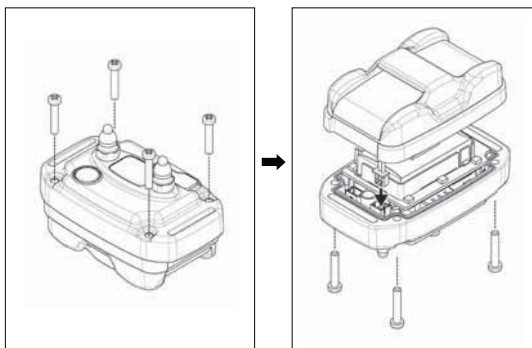

1. Begin with the receiver/collar turned off.
2. Remove the strap and unscrew the Phillips head screws on the four corners of the receiver/collar.
  - \* Unscrew the screws with a firm grip, taking extra caution to not strip the screws.
3. Remove the front case. While holding the battery wire, detach the wire from the battery connector plug.
4. Holding the battery wire of the new battery, plug the wire in to the battery connector plug.
5. Check that the battery connector wire is firmly inserted into the plug. The battery wires must be inside the battery compartment.



\* **Caution** - Do not detach the wire by pulling from the battery.

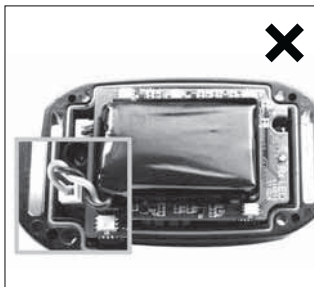

\* **Caution** - The battery wires must run neatly along the top left side in to the battery compartment.

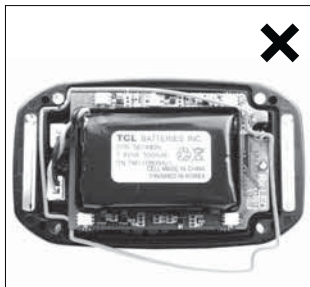

\* **Caution** - The orange rubber gasket is important for the unit to be waterproof and must be properly seated in place.

# General Training Tips

## Getting started

Your dog must know some basic obedience commands before e-collar training. A dog learns by first being shown a command, followed by lots of repetition over an extended period of time. As the dog becomes proficient at these commands, you can introduce distractions and different locations. With the correct amount of positive and negative reinforcement, you should end up with a well-mannered dog.

## On-leash obedience training

Your dog must fully understand the obedience commands (sit, stay, here, heel, and kennel) before using the e-collar for reinforcement of these commands. A leash attached to a standard collar is used to teach the dog basic obedience commands. A tug on the leash/collar is used to reinforce these commands. When your dog complies with the command, use positive reinforcement/praise. Once the dog understands these commands, the e-collar can be used to reinforce them further.

## Beginning e-collar training

When your dog understands on-leash obedience commands, you can start with e-collar training. With the dog on the leash with the e-collar on, continue with your obedience drills. Light stimulation, on nick or constant, is going to be applied as a command is given. The stimulation is removed as the dog complies. Through repetition, the dog learns to stop the light stimulation by performing the commands. E-collar training is another form of negative reinforcement; similar to the leash and standard collar

training. When the dog complies with the command, we use praise/positive reinforcement. The final step is the avoidance phase in which the dog learns that he can avoid the stimulation altogether by performing your commands. When these training procedures are complete, the e-collar is used as a reminder when the dog does not comply with your commands. Keep the initial training sessions short and positive. Dogs have a short attention span, especially younger dogs.

### **How much stimulation to use**

The level of stimulation best suited for your dog depends on your dog's temperament and threshold for stimulation. Always start at the lowest level and work your way up. The appropriate level can be found when the dog responds to the stimulation with a mild reaction such as a tensing of the neck muscles. The stimulation level may vary depending on the training situation. When highly distracted, dogs will require a higher level of stimulation.

For more training information, visit Dogtra's Support/Training section at [www.dogtra.com](http://www.dogtra.com).

# Maintenance

## Basic maintenance

Be sure the rubber-charging cap is securely in place when the collar is in use. After each training session, carefully inspect the unit for any missing parts or damage to the casing. Damaged or broken casing may affect the waterproof guarantee on the unit. After confirming that there is no damage to the casing, rinse the receiver/collar and clean out any dirt or debris.

## Storage maintenance

The Dogtra EDGE should be fully charged before storing for extended periods. While in storage, the unit should be given a full charge once a month, and before the first use. Store the units in room temperature. Do not keep the units exposed to extreme climates.

## Troubleshooting

If the unit is malfunctioning, please refer to the “Troubleshooting Guide” before sending it to Dogtra for service. If you have any questions or concerns, you may email them to [info@dogtra.com](mailto:info@dogtra.com), or call customer service at 1-888-811-9111.

# Troubleshooting Guide

## 1. My dog is not reacting to the collar.

- Make sure the receiver/collar is turned on. To turn the receiver/collar on, hold down the on/off button until the green LED indicator turns on.
- Be sure the strap is on the dog tight enough so that both contact points are touching the dog's skin.
- The contact points may be too short for your dog's thick or long coat. Use the included contact point extensions to extend the length of the contact points. If you are already using longer contact points, you may need to trim the hair on the dog's neck, so that both contact points are touching the dog's skin.
- The intensity level may be too low for your dog. Increase the stimulation until the dog responds, usually by a neck movement, head shaking, or looking over the shoulders. The response may be very subtle.

## 2. The LED indicator light comes on, but I do not feel any stimulation.

- Your tolerance may be higher than your dog's. You may need to try the unit on your fingertips where sensitivity is higher and/or increase the stimulation level. Be sure both contact points are touching both of your fingertips.
- The battery may be low, check the LED indicator light on the transmitter and receiver/collar for battery life.
- Make sure the receiver/collar is coded to the transmitter. To code the receiver/collar to transmitter see section 14. Code Setting.
- If you have a full charge, and you have done all of the above, your unit may need to be serviced. Please email us at [info@dogtra.com](mailto:info@dogtra.com), or call customer service at 1-888-811-9111.



### **3. The transmitter has no range, or the stimulation is weaker when my dog is farther away.**

- Check to see if your fingers are touching the antenna, as the range may decrease substantially.
- The range indicated on the unit's box is for flat terrain (line of sight). Heavy brush, trees, hills, buildings, and/or moisture will affect the range of your unit. For the best range, hold the transmitter vertically above your head, and/or try moving to higher ground.
- Any electrical conductors will affect the range, such as cars, chain-link dog runs, metal buildings, and radio towers. For the best results, operate away from these structures.

### **4. My units are not holding a charge.**

- The charging pin may be damaged. A metal pin inside the charging port should stand straight up and firm in the center. If the pin is wobbling, broken or missing, you will need to send the unit in to the repairs department.
- The charging port must be clean prior to charging, clean the dirt out with a cotton swab and some rubbing alcohol. If the dog was in salt-water, be sure to rinse the receiver and charging port with clean water.
- For Dogtra units over two years old from the purchase date, the batteries may need to be replaced. You can replace them yourself by contacting Dogtra for a replacement battery. Damages incurred to the unit due to improper battery installations are not covered under the warranty. Dogtra strongly recommends sending the unit in for inspection.

### **5. My dog has skin irritation.**

- This may be due to an improper fit. If your dog exhibits signs of skin irritation, consult with a veterinarian. Once the dog's skin returns to a normal condition, continue to use the collar and check your dog's neck each time you use the unit.

# Warranty And Repair Information

## Platinum Limited Lifetime Warranty

Dogtra Company provides the original purchaser with a comprehensive Platinum 2-YEAR WARRANTY for the EDGE. The warranty begins from the date of purchase. For the first two years, coverage is for Parts, Labor, Accessories, and Outbound Shipping.

After the first two years, the Limited Lifetime Warranty covers Parts only. The Limited Lifetime Warranty does not cover Labor Fees and Accessories such as chargers, splitter cables, antennas, straps, and batteries. The cost of Accessories, Labor fees, and Shipping fees incurred are the customers' responsibility. Labor fees will be variable depending on the extent of the work required. The Limited Lifetime Warranty expires 5 years after a model is discontinued from production by Dogtra.

## To Qualify for the Dogtra Warranty

All products must be registered and/or a proof of purchase is required to initiate repair work under warranty. To register your Dogtra product, log onto our website at [www.dogtra.com](http://www.dogtra.com), click on the warranty registration link, and fill out the required information. Registration must be completed within 30 days of purchase. If you do not have access to a computer, you can call our toll free number at 1-888-811-9111, and one of our customer service representatives will register the product for you. If you were unable to register your product within 30 days of purchase, we will accept all products for repair with a proof of purchase. We strongly recommend keeping the original receipt. If your product is not registered and a proof of purchase is not available at the time of service, Dogtra will estimate the age of the unit by the serial number. Serial number estimates can differ from the actual purchase date. A serial number estimate is the only method of determining an approximate date of purchase without product registration or a proof of purchase.

## Not Covered Under Warranty

Dogtra does not offer warranty for products that have been bought secondhand or as a resold product.

Dogtra DOES NOT replace defective units or provide refunds for products purchased from us after 30 days from the date of purchase.

Issues of replacement and refunds on units purchased less than 30 days from an authorized dealer must be addressed to the dealer directly. If the products purchased from an authorized dealer are after 30 days from the date of purchase, please send the units to Dogtra for service and repair.

Dogtra DOES NOT cover the cost of repairs and replacements due to misuse by the owner or dog, improper maintenance, and/or lost units. All replacement costs for either the transmitter or receiver will be the owner's responsibility.

The warranty is void if the unit has been altered or an unauthorized person has damaged the unit while attempting repair work.

Battery replacement by the customer during the first two years of the Platinum Limited Lifetime Warranty is not recommended. If the customer chooses to replace the batteries, any damage to the unit during the change-out by the owner will void the warranty.

The removal of serial numbers from any Dogtra products will void the warranty.

Dogtra reserves the right to retain and discard any parts or accessories that have been found damaged upon replacement and repair.

**Procedure for Repair Work**

If the unit is malfunctioning, please refer to the “Troubleshooting Guide” in the Owner’s Manual and call customer service at 1-888-811-9111, for technical support, before sending it to Dogtra for Service.

The cost of shipping products under warranty back to Dogtra is the customer’s responsibility. Dogtra is not responsible for units damaged or lost in transition to Dogtra. Dogtra is not responsible for loss of training time or inconvenience while the unit is in for repair work. Dogtra does not provide loaner units or any form of compensation during the repair period.

A copy of the sales receipt showing the purchase date may be required before warranty work is initiated.

Please include a brief explanation outlining the problem and include your name, address, city/state/zip code, daytime phone number, evening phone number, and email address. Or you can visit our website at [www.dogtra.com](http://www.dogtra.com) for a service request form. If the repair costs are not covered under warranty, we will call you for payment information and authorization. For any questions concerning your Dogtra products, call us toll free at 1-888-811-9111, M-F 8:30AM - 4:00PM, Pacific Standard Time, or email us at [repair@dogtra.com](mailto:repair@dogtra.com) for specific repair inquiries.

**Send repair units to Dogtra Company / Repairs / 22912 Lockness Avenue Torrance, CA 90501 U.S.A.**

***EDGE*** by Dogtra Company

22912 Lockness Ave.

Torrance, CA 90501 U.S.A.

Tel: 310-534-0101

Fax: 310-534-9111

Toll free: 1-888-811-9111

Email: [info@dogtra.com](mailto:info@dogtra.com)

Website: [www.dogtra.com](http://www.dogtra.com)

Store website: [shop.dogtra.com](http://shop.dogtra.com)

memo

memo



**Dogtra Company**

22912 Lockness Avenue  
Torrance, CA 90501 U.S.A.

Tel) 310.534.0101

Fax) 310.534.9111

Toll free) 1.888.811.9111

Store website) [shop.dogtra.com](http://shop.dogtra.com)